



WHAT DO THESE HAVE IN COMMON:



95 %



70 %



97 %



100 %



100 %



100 %



100 %



100 %



40 %



100 %



100 %



100 %

ALL OF THEM HAVE A GEARBOX IN THEIR POWER-TRAIN

GEARS IN CARS

All cars in the world have a geared transmission,
both traditional and electric cars



AC motor + gear

BOSCH electric car, power train



AC motor + gear

TESLA electric motor & gear



AC motor + gear

Other car gear and motor

GEARS IN AVIATION

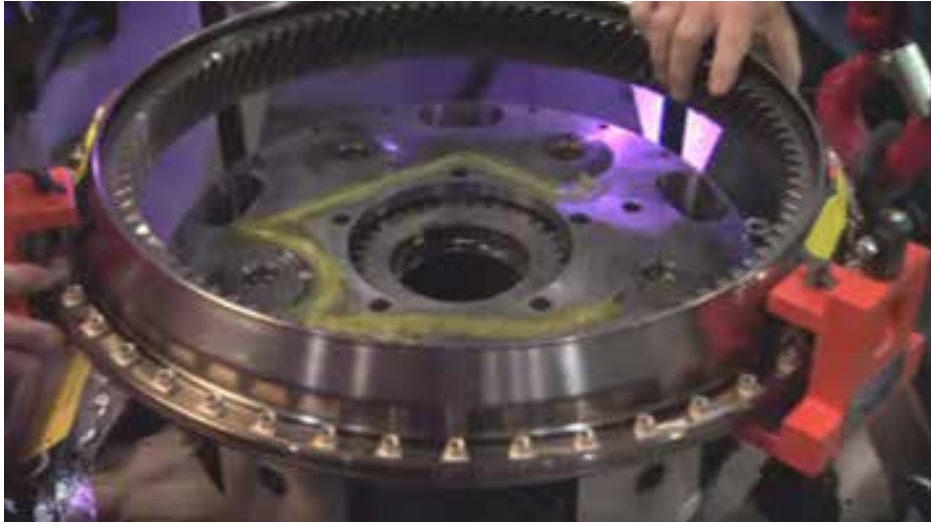

The ultracompact Kawasaki-made planetary gear used in the new Pratt & Whitney PurePower PW1500G Geared Turbofan Jet engines.

Gear efficiency = 99 %, 20 % less fuel consumption, and 75 % less noise – by introducing the gearbox !

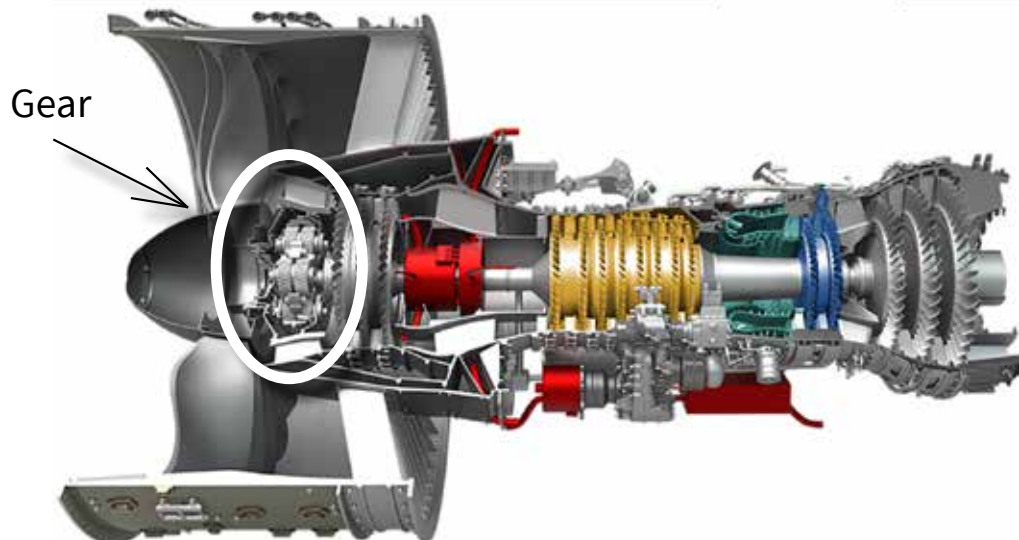

All turboprop airplanes have a geared solution.
All helicopters also depend on a gearbox.

GEARS IN INDUSTRY



GEARS IN NATURE



Planthopper Nymphs (*Issus coleoptratus*)

As the planthopper jumps, the gears ensure that its legs rotate together and extend at the same time.

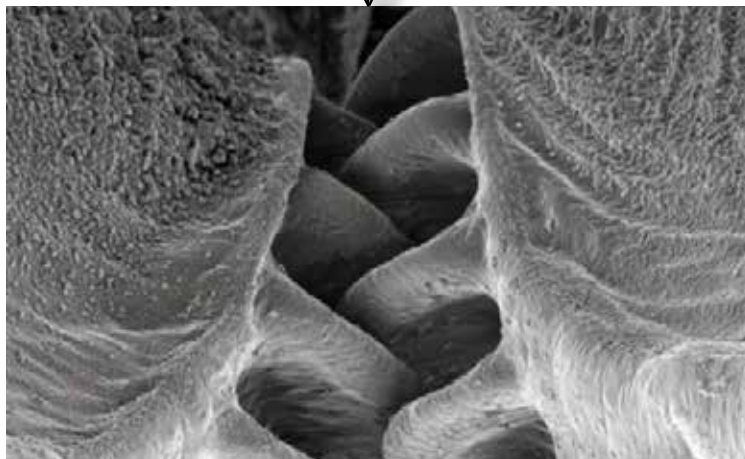
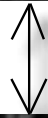
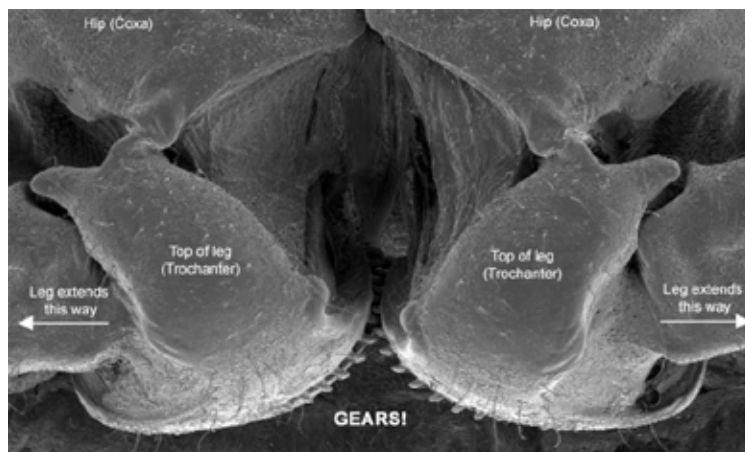

GEARS IN SHIPS



STADT Lean Propulsion.

A typical gearbox in green colour.

Geared electric propulsion combined with STADT Lean Propulsion®
- can save as much as 70 - 90 tonns on a bigger ship installation.

Bigger propeller, at low revolution,
gives much higher efficiency -
by using a gearbox



Nauðsynlegt vélarafi til að ná 30 tonna togsþyrnu



FUEL SAVING:

Proven -
30 to 40 %

MS "Breki"
Iceland

STADT LEAN ELECTRIC PROPULSION , USING GEARED AC-MOTORS.

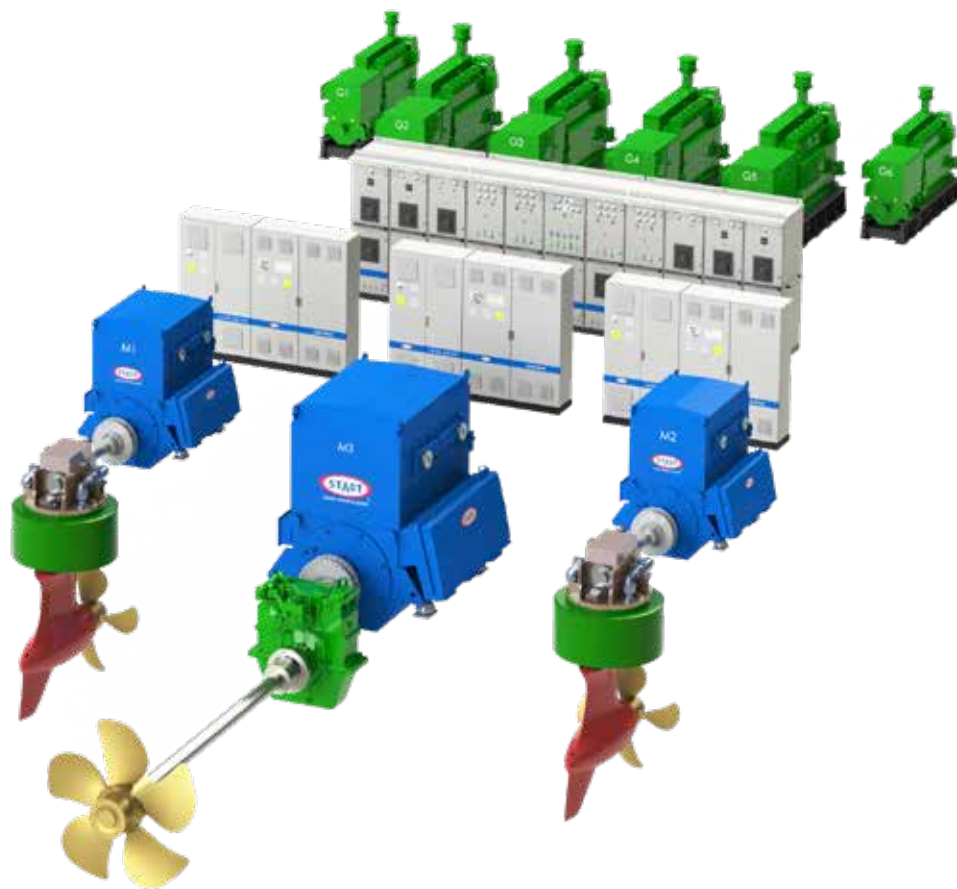

AND THE REASON IS HERE :

A motor that runs on a high RPM, is much more compact than a slow speed version. The 3000 kW 1500 rpm motor has the same size and weight as a 300 kW 150 rpm motor ! - RPM matters, a lot.



10 : 1 RPM



10 : 1 POWER

This leads to solutions that incorporates a gearbox, to increase performance and reduce size, weight, noise, and costs.

PHOTO GALLERY



Bicycle without gear - in museum

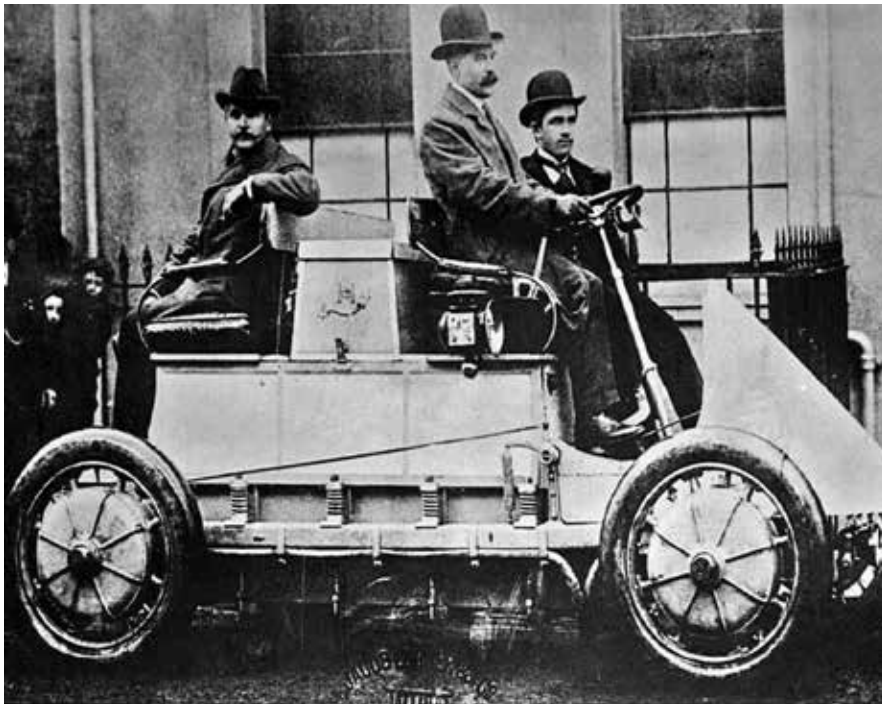

PORSCHE - electric car without gear -
in museum since year 1900.
Gearless cars have never been successful.

Some companies, like GE, claim that geared electric transmissions belong in museums.

This paper shows how wrong such a statement is.

The truth is:

Gearless solutions are found only in museums.

WITHOUT GEARS - EVERYTHING STOPS



LEAN PROPULSION

Stealth Electric propulsion
For any NAVAL & Research ship

STADT NAVAL AS

Moljevegen 50 | N-6083 Gjerdsvika | Norway
Tel.: +47 700 25 800 | navalsales@stadt.no | www.stadt.no